



Donaldson
FILTRATION SOLUTIONS

DUST COLLECTORS DOWNFLO OVAL



Easy to use - Compact - Powerful

Simply the best Dust Collectors available

The full line of DFO collectors offer a variety of benefits that distinguish them from all other collectors available in the market today:

- Easy to use. Quick-release handles provide easy cover removal and faster filter access.
- Compact. Smaller footprints for applications that require maximum cleaning efficiency in even smaller spaces.
- Powerful. DFO collectors provide 25 % more capacity than same-sized dust collectors.
- Cost effective. The Donaldson proprietary ExtraLife Filter Cleaning System averages up to 30 % increase in pulse cleaning energy for unmatched cleaning ability.
- Innovative unique. Oval-shaped Ultra-Web® cartridge filters provide the longest filter life and highest filtration efficiency – which lowers total costs of operation.



Normal Operations for Models 2-8 to 4-128

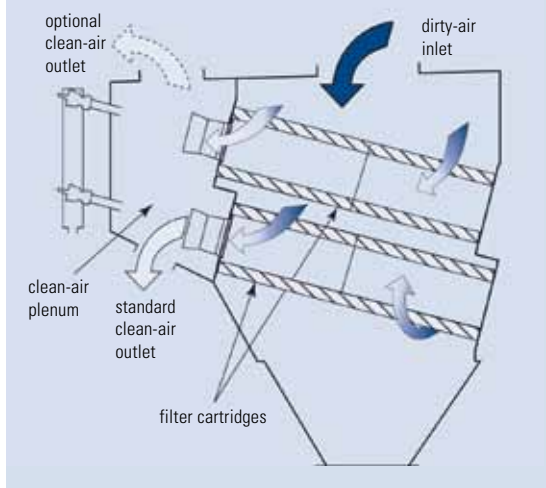

DFO Models 1-1 to 4-128

- 26 standard model sizes
- Customised sizes available
- Many options and accessories
- Exceptionally compact design
- Highest energy savings



DFO Models 1-1, 2-2 and 3-3

- Incorporate several exclusive and unique features
- Completely self-contained, "plug-and-play" type units
- Packaged with power pack, controls, silencer, damper, dust container and more
- Remarkably quiet operation
- Exceptionally compact design
- Easily movable



High Performance Filters

The remarkable Story of DFO began with the oval Cartridge Filter itself

Ultra-Web® Nanofiber Media. A dramatic departure from traditional circular-shaped cartridge filters, DFO's oval-shaped filters, in conjunction with our innovative nanofiber filter media, trap more dust on the surface of the filter than conventional commodity types of filter media such as depth-loading cellulose, polyester or cellulose/polyester blend.

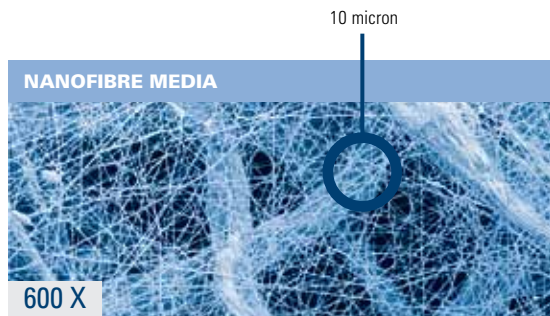

Nanofiber technology is available in all Ultra-Web® and Fibra-Web cartridges.

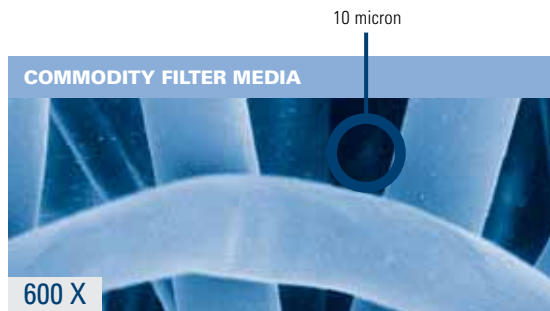

Conventional media has spaces of up to 60 microns between filbers, allowing dust to become deeply embedded.

The Innovation continues with DFO's shorter, stiffer Filter Media Pleats

DFO Filter Media Pleats. Shorter and compact filter media pleats help minimise dust build up and simplify filter cleaning. By reducing the height of the filter pleats from the standard 50 mm to 38 mm, the pleat wall is stiffer and more compact, which improves the filter cleaning efficiency.

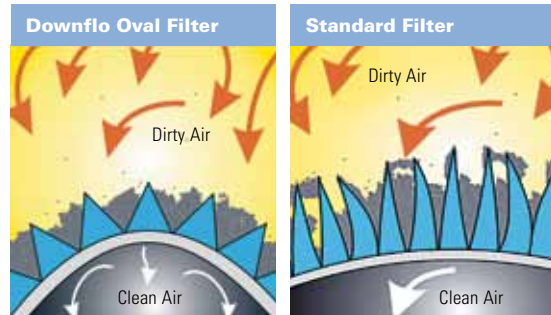

Unique oval Shape contributes to higher Airflow Capacity

High Performance Filters. The Downflo Oval filter design is a reflection of Donaldson's commitment to technical research and development. Oval-shaped filters handle up to 25 percent more airflow without increasing velocities. Sophisticated Fluent®* airflow modelling software revealed that oval-shaped cartridge dust collectors have fewer areas of high velocity, resulting in a lower potential for media abrasion and increased filter life.

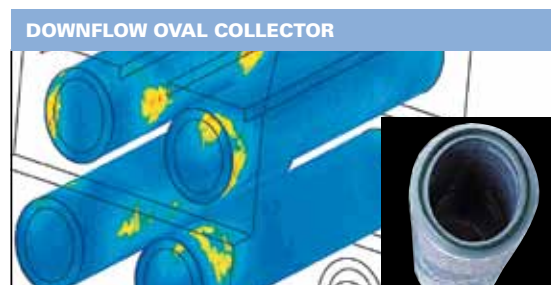
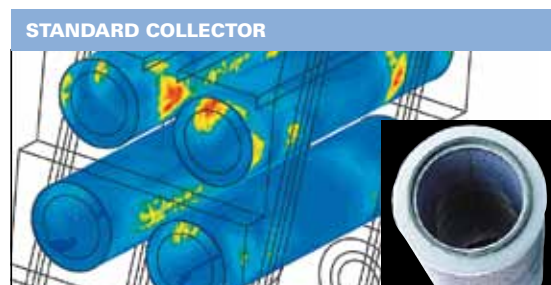

*FLUENT® is a registered trademark of Fluent, Inc.

Prolonged Filter Life

Technical Discoveries improved Filtration Performance and prolonged Filter Life

Convex Side Walls. A new casing design with convex side walls streamlines the airflow path and increases the casing's cross-sectional area. The convex side walls provide more space between filters, lowers velocities and optimizes the Downflo air flow principle.

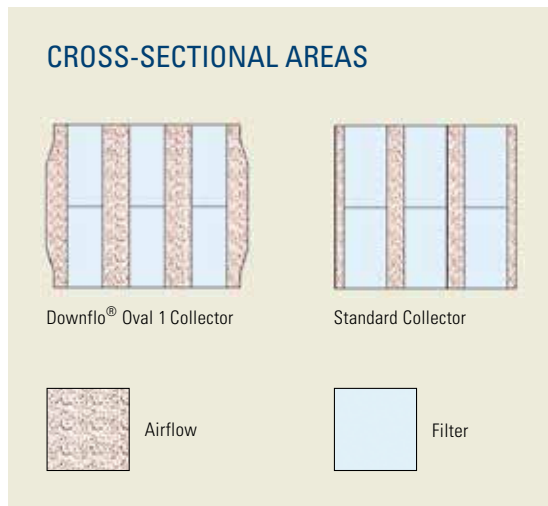

Cross-sectional area of collector dirty air.

Pulse Cleaning Technology. ExtraLife Filter Cleaning System uses proprietary, computer-modelled pulse cleaning technology to easily "pulse off" dust from the surface of the filter, improving filtration capacity and prolonging filter life.

The red lines in the below illustration show the increased pulse pressure at the front of the Downflo filter generated by the ExtraLife system. The blue line shows the pulse signature of a standard cartridge collector.

Easy Filter Changes

Easy Maintenance. With the new design of the DFO's quick-release access handles, filter removal and maintenance is extremely fast with one simple movement of the clamp.



Bag-In/Bag-Out arrangements improve filter change-outs and hopper discharge maintenance, help minimize worker exposure to potentially harmful dusts, and reduce exposure of contaminants to the atmosphere.

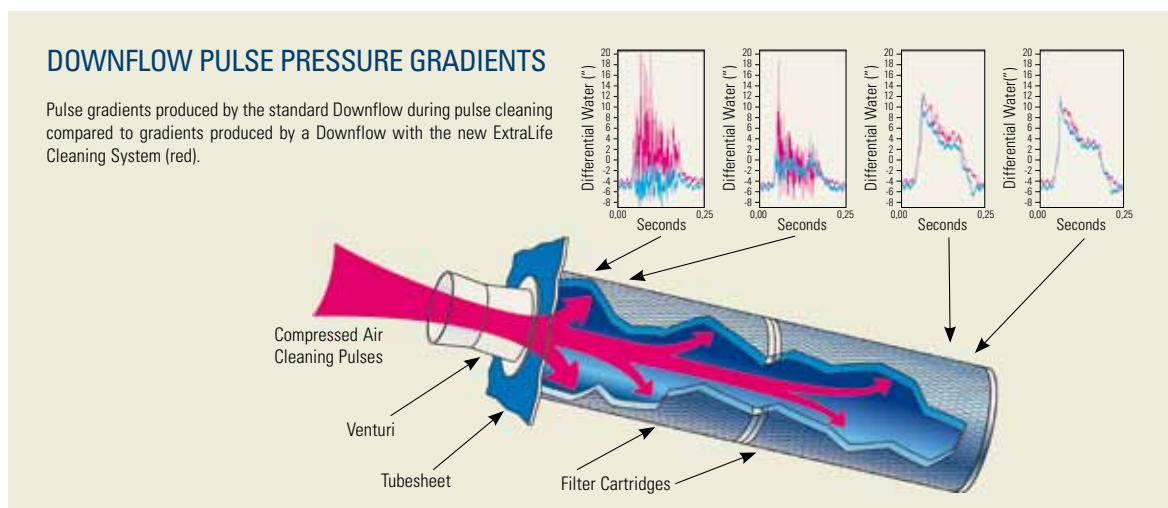

DFO Cartridge Filters

DFO dust collectors' innovative downward airflow design delivers highest filtration efficiency while using less energy. The DFO dust collector, proprietary ExtraLife filter cleaning and Donaldson's unique oval-shaped filter cartridges are an unbeatable system. Choose from our superior line of quality cartridge filter media to complete the most powerful dust collection solution available:

Ultra-Web®

Featuring proprietary nanofiber technology, Ultra-Web® cartridges provide unequalled filtration efficiency. This advanced surface filtration technology ensures longest filter life and lowest operating pressure drop.

- Premium performance on ambient, extremely fine and non-fibrous dust and some abrasive dust.
- High filtration efficiency on very fine particulate of < 1 micron.



Ultra-Web® on Spunbond

Featuring proprietary nanofiber technology, Ultra-Web® on Spunbond cartridges provide unequalled filtration efficiency.

- Wide pleat spacing provides excellent particle release.
- Highly recommended for chemical, food and industrial processing when product contamination must be minimized.
- Excellent performance on moist, hygroscopic or agglomerative dust.
- High filtration efficiency on very fine particulate < 1 micron.



Torit-Tex

With a high tolerance for moisture, Torit-Tex cartridges provide exceptional filtration efficiency.

- Wide pleat spacing and smooth, hydrophobic, state-of-the-art ePTFE membrane provides excellent particle release.
- Highly recommended for chemical, food and industrial processing when product contamination must be minimized.
- Excellent performance on moist, hygroscopic or agglomerative dust.



Fibra-Web

Fibra-Web filters feature an open washable design for easy cleaning in both fibrous and non-fibrous (agglomerative) applications a proprietary blend of synthetic fibres provide filtration efficiency.

- Wide pleat spacing provides thorough pulse cleaning of fibrous and agglomerative particles .
- Excellent performance on combination fibrous and non-fibrous dust, and/or agglomerative dust.
- High filtration efficiency on very fine particulate of < 1 micron.



Thermo-Tek

Designed for high-temperature applications, Thermo-Tek cartridges have a proprietary media that offers exceptional filtration efficiency. Special heat-resistant construction and gaskets maintain seal strength and integrity at temperatures up to 135 °C (275 °F).



Equipment Options and Features

Options for DFO 1-1 through 4-128

- ATEX compliance
- Full range of inlet adaption pieces
- Spark trap*
- Steep-sided hoppers
- Explosion vents
- Slide gates
- Hostile environment paint
- Afterfilters
- Chamber and exhaust silencers**
- Air management module**
- Extended dirty air plenum**
- Rotary valves and transitions**
- Service platform**
- Total control board**
- UCS controller*
- Flexible extraction arm*
- "Plug and Go" arrangement*
- "Bag in/Bag out" arrangement
- Disposable BIM Liner with pressure balance arrangement*
- Oil/Water separator

Standard Features for DFO 1-1 through 4-128

- Ultra-Web® and other Donaldson cartridges
- ExtraLife Filter Cleaning System
- Quick removal cartridge access
- Ledge-free hopper

DFO offers:

- Lower investment cost per cubic meter of air per hour (m³/h)
- Lower energy consumption and hence reduction of CO₂ emissions
- Longer filter life time
- Ease of maintenance
- Efficient cleaning systems
- ATEX-compliant solutions

* DFO 1-1, 2-2 and 3-3 ** DFO 4-128

Donaldson
Torit® DCE®

Dust and Fume Removal · Oil Mist Separation



Donaldson
FILTRATION SOLUTIONS

Total Filtration Management

Donaldson offers a wide variety of solutions to reduce your energy costs, improve your productivity, guarantee production quality and help protect the environment.

Total Filtration Service

A comprehensive range of services especially designed to keep your production at peak performance and at the lowest total cost of ownership.

Please contact us:

Donaldson Europe B.V.B.A.

Research Park Building No. 1303 · Interleuvenlaan 1

B-3001 Leuven · Belgium

Tel +32(0)16 38 38 11 · Fax +32(0)16 40 00 77

IAF-europe@donaldson.com · www.donaldson.com